

User Manual



EAP900H
version 1.0

Dual Band N900 Indoor Access Point
Ceiling Mount Design

IMPORTANT

To install this Access Point please refer to the **Quick Installation Guide** included in the product packaging.

Table of Contents

Chapter 1 Product Overview.....	4	Chapter 7 Wireless	31
Key Features/Introduction.....	5	Wireless Network.....	31
System Requirements/Package Contents.....	6	Wireless Security.....	34
Applications.....	7	Wireless MAC Filtering.....	40
Technical Specifications.....	8	Wireless Advanced	41
Physical Interface.....	9	WPS (Wi-Fi Protected Setup).....	42
Chapter 2 Before You Begin	10	WDS Link Settings.....	43
Considerations for Wireless Installation.....	11	Chapter 8 Management.....	44
Computer Settings.....	12	Administration.....	45
Hardware Installation.....	15	Management VLAN Settings.....	46
Mounting the EAP900H.....	16	Wireless Traffic Shaping.....	47
Chapter 3 Configuring Your Access Point.....	18	SNMP Settings.....	48
Default Settings.....	19	Backup/Restore.....	50
Chapter 4 Building a Wireless Network.....	20	Auto Reboot Settings.....	51
Access Point Mode.....	21	Firmware Upgrade/Time Settings.....	52
WDS AP Mode.....	22	System Log/Tools.....	54
WDS Bridge Mode.....	23	Ping Test Parameters/Traceroute Parameters.....	55
Chapter 5 Overview.....	24	SpeedTestParameters/LEDControl.....	56
Overview.....	25	Device Display/Reset.....	57
Connections.....	26	Appendix	58
Chapter 6 Network	27	FCC Interference Statement.....	59
Operation Mode/Basic.....	28	IC Interference Statement.....	60
IP Settings/Spanning Tree Settings.....	29	CE Interference Statement.....	62

Chapter 1

Product Overview



Introduction

Key Features

- Up to 28 dBm transmit power, enabling long range connectivity
- Supports IEEE802.11a/b/g/n wireless standards with up to 450 Mbps data rate on each band
- Six internal 5dBi Omni-Directional MIMO antennas
- Can be monitored after deployment with EnGenius EZ Controller™ software for Windows (Free online download)
- Can be used with included power adapter or via PoE with PoE 802.3at - capable Switches or Injectors
- Dual Band/Three Stream
- Band Steering shifts dual band clients to 5 GHz for better throughput performance
- Secured Guest Network

can be used with
802.3at
capable switches or injectors



Introduction

The EAP900H is a high-powered, long-range, Dual-band concurrent Wireless 802.11a/b/g/n Access Point with three major functional modes. It is designed to operate in numerous environments; from large homes, small and medium-sized businesses, multiple-floor offices, hotels, and other venues, to larger enterprise deployments. Its high-powered, long-range characteristics make it a cost-

effective alternative to ordinary Access Points that don't have the range and reach to connect to a growing number of wireless users who wish to connect to a large home or business network.

Maximum data rates are based on IEEE 802.11 standards. Actual throughput and range may vary depending on many factors including environmental conditions, distance between devices, radio interference in the operating environment, and mix of devices in the network. Features and specifications subject to change without notice. Trademarks and registered trademarks are the property of their respective owners. For United States of America: Copyright © 2013 EnGenius Technologies, Inc. All rights reserved.

The EAP900H supports the 2.4 GHz frequency band under the 802.11b/g/n mode while at the same time providing a 5 GHz band for communicating or transferring files in a less congested network frequency band.

The EAP900H also delivers up to 6x faster wireless speeds compared to legacy 802.11a/b/g wireless devices. Even though the EAP900H has been designed and engineered for heavy traffic and demanding business environments, in larger housing environments as it can efficiently extend the wireless range of an existing home router. This makes it especially ideal in architecturally-challenging structures, providing whole home connectivity.

To protect sensitive data during wireless transmissions, the EAP900H offers different encryption settings for wireless transmissions, including industry standard WPA and WPA2 encryption. The EAP900H also includes MAC address filtering to allow network administrators to offer network access only to known computers and other devices based on their MAC addresses.

System Requirements

The following are the Minimum System Requirements in order to configure the device:

- Computer with an Ethernet interface or wireless network capability
- Windows OS (XP, Vista, 7, 8), Mac OS, or Linux-based operating systems
- Web-Browsing Application (i.e. : Internet Explorer, Firefox, Chrome, Safari, or another similar browser application)

Package Contents

The EAP900H package contains the following items (all items must be in package to issue a refund):

- EAP900H Access Point
- Power Adapter
- RJ-45 Ethernet Cable
- Quick Installation Guide
- Ceiling and Wall Mount Screw kit

Applications

Wireless LAN (WLAN) products are easy to install and highly efficient. The following list describes some of the many applications made possible through the power and flexibility of WLANs:

- **Difficult-to-Wire Environments:** There are many situations where wires cannot be installed, deployed easily, or cannot be hidden from view. Older buildings, sites with multiple buildings, and/or areas that make the installation of a Ethernet-based LAN impossible, impractical or expensive are sites where WLAN can be a network solution.
- **Temporary Workgroups:** Create temporary workgroups/networks in more open areas within a building; auditoriums, amphitheaters classrooms, ballrooms, arenas, exhibition centers, or temporary offices where one wants either a permanent or temporary Wireless LAN established.
- **The Ability to Access Real-Time Information:** Doctors/Nurses, Point-of-Sale Employees, and/or Warehouse Workers can access real-time information while dealing with patients, serving customers, and/or processing information.
- **Frequently Changing Environments:** Set up networks in environments that change frequently (i.e.: Show Rooms, Exhibits, etc.).
- **Small Office and Home Office (SOHO) Networks:** SOHO users require a cost-effective, easy, and quick installation of a small network.
- **Wireless Extensions to Existing Ethernet-based Networks:** Devices like the EAP900H enable network administrators, installers, and end-users to extend the range and reach of an existing Ethernet-based network.
- **Training/Educational Facilities:** Training sites at corporations or students at universities use wireless connectivity to exchange information between peers and easily access information for learning purposes.

Technical Specifications

Standard:

IEEE802.11b/g/n on 2.4 GHz

IEEE 802.11a on 5 GHz

IEEE802.3at

Antenna

Six Internal 5 dBi Omni-Directional Antennas

Physical Interface

1 x 10/100/1000 Gigabit Ethernet Port

1 x Reset Button

1 x Power Connector

LED Indicator

Power

WPS

WLAN (Wireless Connection)

LAN

Power Requirements

External Power Adapter

DC IN, 12V/2A

Operation Modes

Access Point

WDS AP

WDS Bridge

Security

WEP (64/128bit)

WPA/WPA2 (TKIP/AES)

Hidden ESSID

MAC address filtering, up to 50 fields

L2 Isolation

802.1X Authenticator (MD5/TLS/TTLS/PEAP)

Guest Network

QoS (Quality of Service)

WMM (Wireless Multimedia)

Physical/Environment Conditions

Operating:

Temperature: 32°F to 104°F (0°C to 40°C)

Humidity (Non-condensing): 90% or less

Storage:

Temperature: -4°F to 140°F (-20°C to 60 °C)

Humidity (Non-condensing): 90% or less

Physical Interface

Dimensions and Weights

Diameter: 6.36"

Height: 2.17"

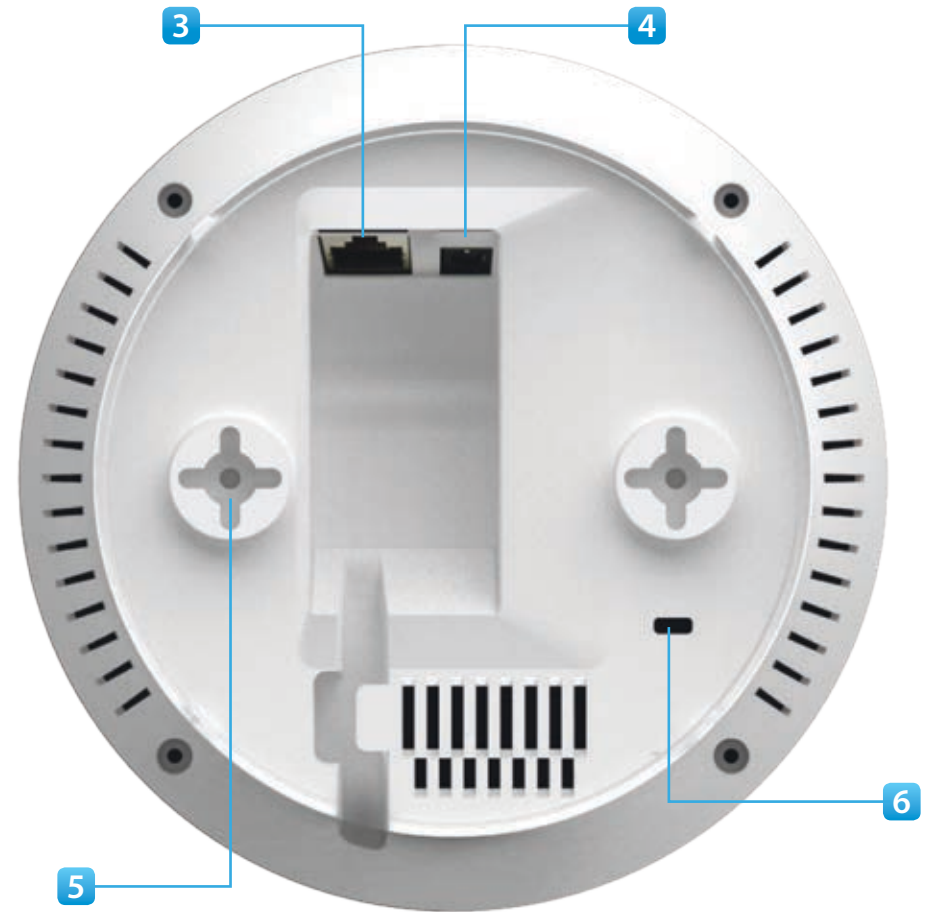
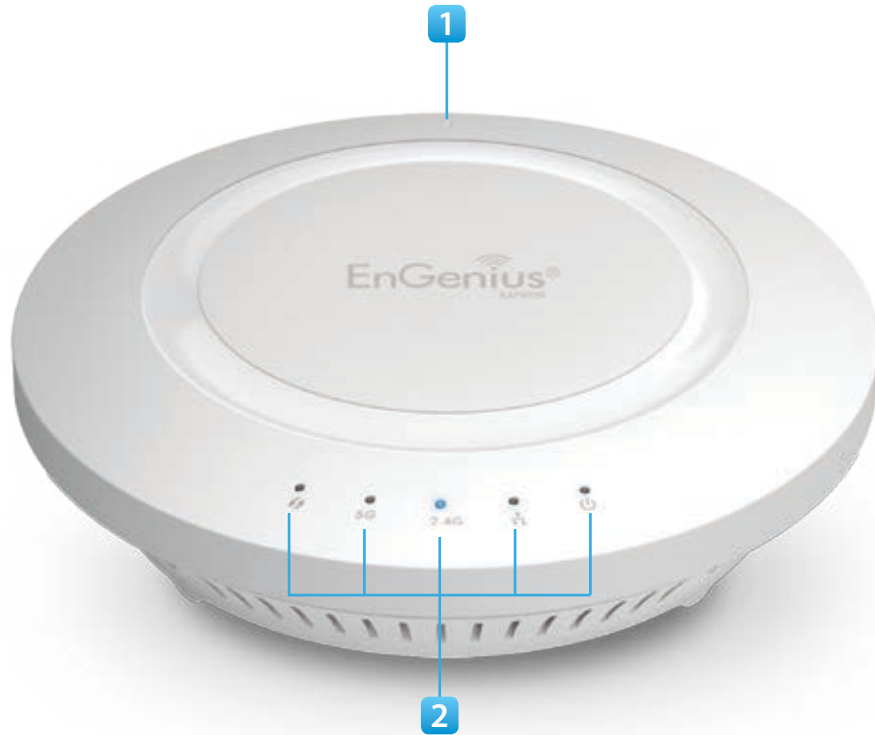

- 1 Reset Button:** Press and hold for **over** 10 seconds to reset to factory default settings.
- 2 LED Indicators:** LED lights for WPS, WLAN 5G, WLAN 2.4G, Ethernet port, and Power
- 3 LAN Port (802.3at PoE):** Ethernet port for RJ-45 cable.

- 4 Power Connector: 12V DC IN** for Power.
- 5 Ceiling (Wall) Mount Hole:** Using the provided hardware, the EAP900H can be attached to a ceiling or wall.
- 6 Kensington Security Slot:** To protect your EAP900H, use the Kensington Security Slot to attach a cable lock.

Chapter 2

Before You Begin



Before You Begin

This section will guide you through the installation process. Placement of the EnGenius EAP900H is essential to maximize the Access Point's performance. Avoid placing the EAP900H in an enclosed space such as a closet, cabinet, or stairwell.

Considerations for Wireless Installation

The operating distance of all wireless devices can often not be pre-determined due to a number of unknown obstacles in the environment in which the device is deployed. Obstacles such as the number, thickness, and location of walls, ceilings, or other objects that the EAP900H's wireless signals must pass through can weaken the signal. Here are some key guidelines for allowing the EAP900H to have an optimal wireless range during setup.

- Keep the number of walls and/or ceilings between the EAP900H and other network devices to a minimum. Each wall and/or ceiling can reduce the signal strength, resulting in a lower overall signal strength.
- Building materials make a difference. A solid metal door and/or aluminum studs may have a significant negative effect on the signal strength of the EAP900H. Locate your wireless devices carefully so the signal can pass through drywall and/or open doorways. Materials such as glass, steel, metal, concrete, water (example: fish tanks), mirrors, file cabinets, and/or brick can also diminish wireless signal strength.
- Interference from your other electrical devices and/or appliances that generate RF noise can also diminish the EAP900H's signal strength. The most common types of devices are microwaves or cordless phones.

Computer Settings

Windows XP/Windows 7

In order to use the EAP900H, you must first configure the TCP/IPv4 connection of your Windows OS computer system.

1. Click the **Start** button and open the **Control Panel**.



Windows XP

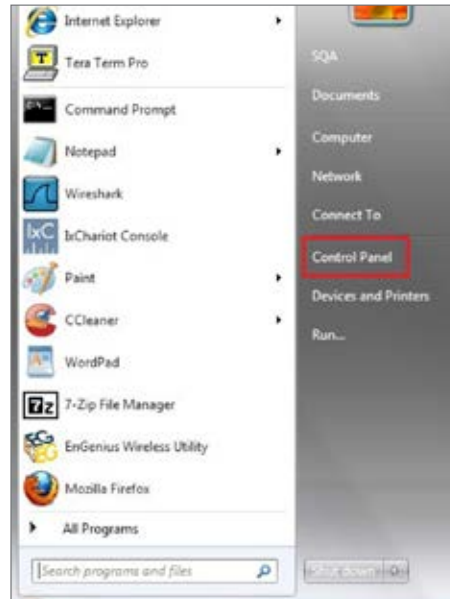

Windows 7

2a. In **Windows XP**, click on **Network Connections**.



2b. In **Windows 7**, click **View Network Status and Tasks** in the **Network and Internet** section, then select **Change Adapter Settings**.



3. Right click on **Local Area Connection** and select **Properties**.



4. Select **Internet Protocol Version 4 (TCP/IPv4)** and then select **Properties**.

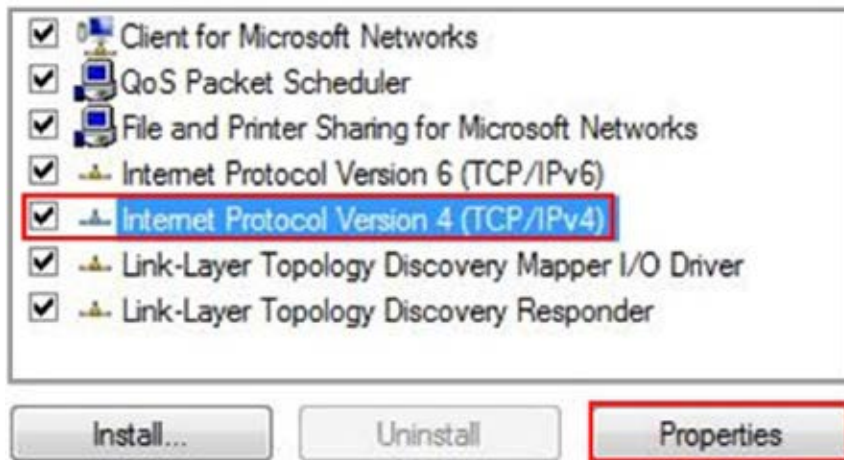

5. Select **Use the following IP address** and enter an IP address that is different from the EAP900H and Subnet mask, then click **OK**.

Note: Ensure that the IP address and Subnet mask are on the same subnet as the device.

For example: EAP900H IP address: 192.168.1.1

PC IP address: 192.168.1.2 - 192.168.1.255

PC Subnet mask: 255.255.255.0



Apple Mac OS X

1. Go to **System Preferences** (it can be opened in the Applications folder or by electing it in the Apple Menu).
2. Select **Network** in the **Internet & Network** section.



3. Highlight **Ethernet**.

4. In **Configure IPv4**, select **Manually**.
5. Enter an IP address that is different from the EAP900H and Subnet mask, then click **OK**.

Note: Ensure that the IP address and Subnet mask are on the same subnet as the device.

For example: EAP900H IP address: 192.168.1.1

PC IP address: 192.168.1.2 - 192.168.1.255

PC Subnet mask: 255.255.255.0

6. Click **Apply** when finished.

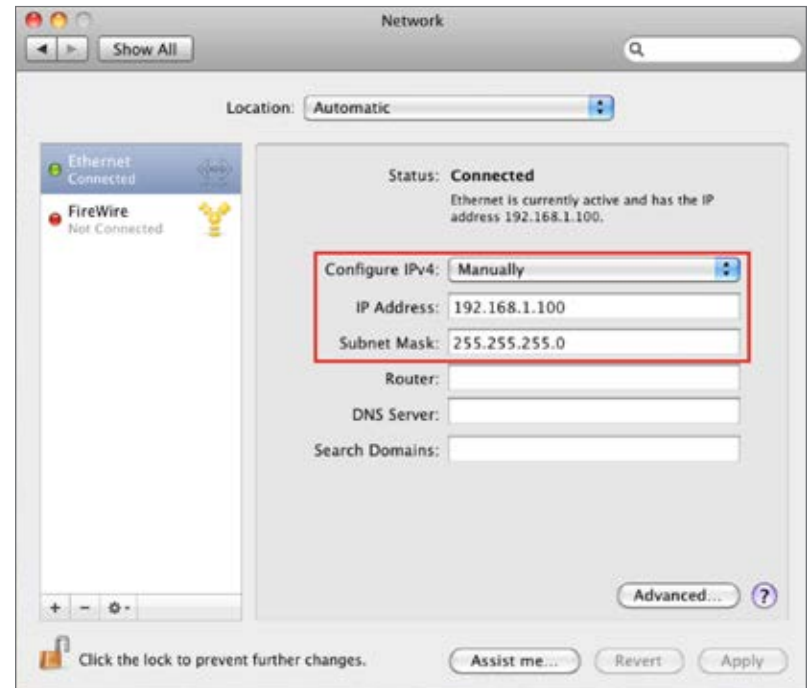

Hardware Installation

1. Ensure that the computer in use has an Ethernet Controller port (RJ-45 Ethernet Port). For more information, verify with your computer's user manual.
2. Connect one end of the Category 5e Ethernet cable into the RJ-45 port of the EAP900H and the other end to the RJ-45 port of the computer. Ensure that the cable is securely connected to both the EAP900H and the computer.
3. Connect the Power Adapter DC connector to the DC-IN port of the EAP900H and the Power Adapter to an available electrical outlet. Once both connections are secure, verify the following:
 - a) Ensure that the **POWER** light is on (it will be **orange**).
 - b) Ensure that the 2.4 GHz/5 GHz WLAN light is on (it will be **blue** for 2.4G, and **green** for 5G).
 - c) Ensure that the LAN (Computer/EAP900H Connection) light is on (it will be **blue**).
 - d) Once all three lights are on, proceed to set up the Access Point using the computer.

This diagram depicts the hardware configuration.

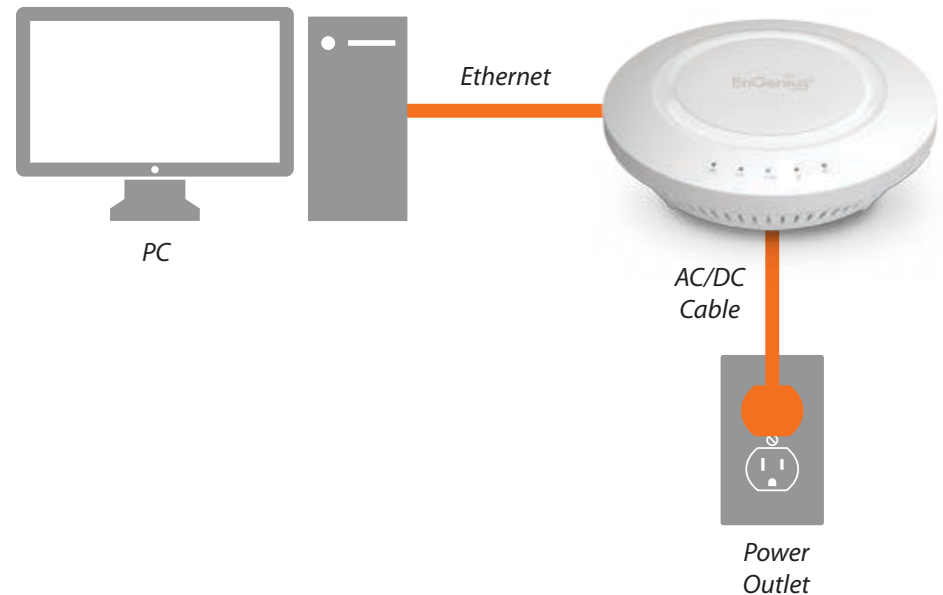

Mounting the EAP900H

Using the provided hardware, the EAP900H can be attached to a ceiling or wall.

To attach the EAP900H to a ceiling or wall using the mounting bracket:

1. Attach the mounting bracket to the wall or ceiling using the provided wall/ceiling mounting hardware kit.
2. Insert the provided short screws into the bottom cover of the EAP900H.

Leave enough of the screws exposed to ensure that the unit can be attached to the mounting bracket.

If extra space is required, use the provided spacers and long screws from the T-Rail mounting hardware kit to increase the space between the unit and the mounting bracket.

3. Mount the EAP900H on the mounting bracket by rotating the unit clockwise about 90 degrees to secure it in place.

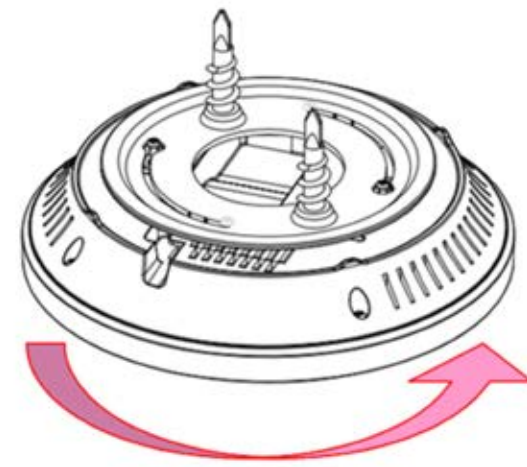
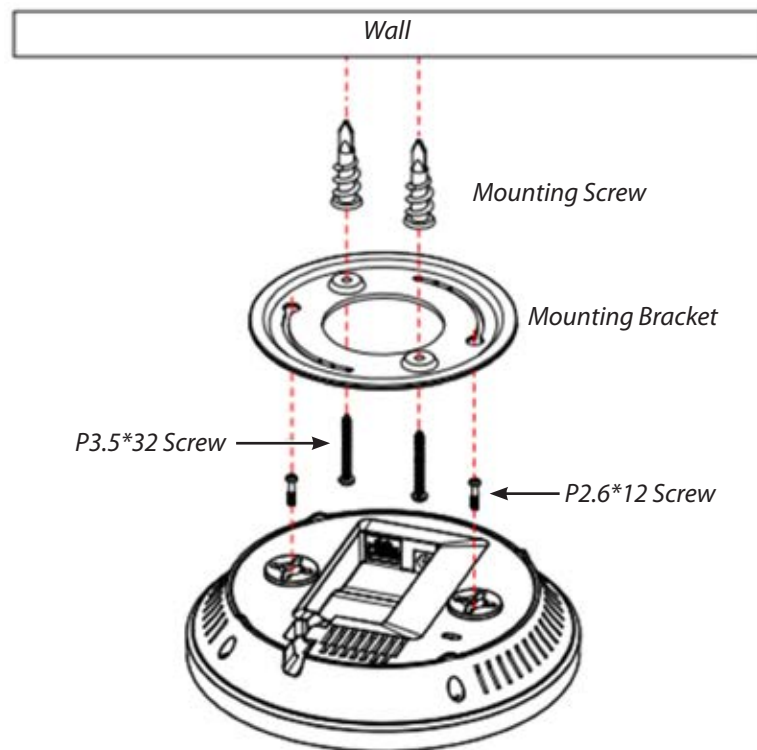

Lock the EAP900H by revolving

Attaching the EAP900H to a ceiling using the provided T-Rail connectors:

1. Attach the T-Rail connectors to the bottom cover of the EAP900H using the provided short screws.

Note: Two sizes of T-Rail connectors are included in the mounting hardware kit: 15/16in (2.38cm) and 9/16in (1.43cm). If extra space is required to accommodate drop ceiling tiles, use the provided spacers and long screws.

2. Line up the connected T-Rail connectors with an appropriately sized rail and press the unit onto the rail until it snaps into place.

Note: To protect your EAP900H, use the Kensington Security Slot to attach a cable lock (cable lock is not included).

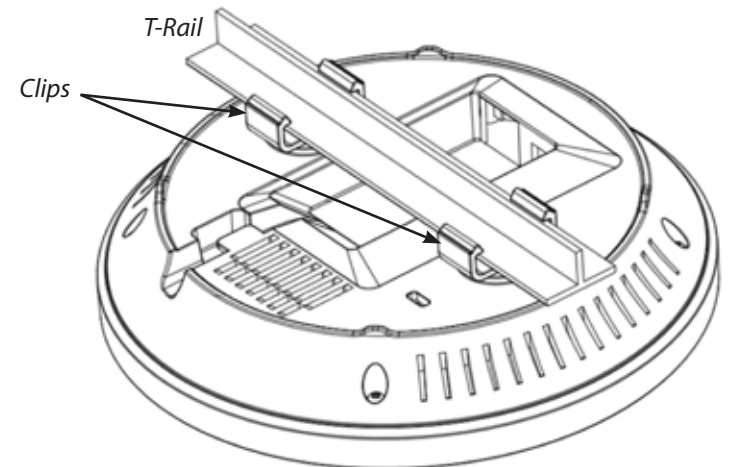
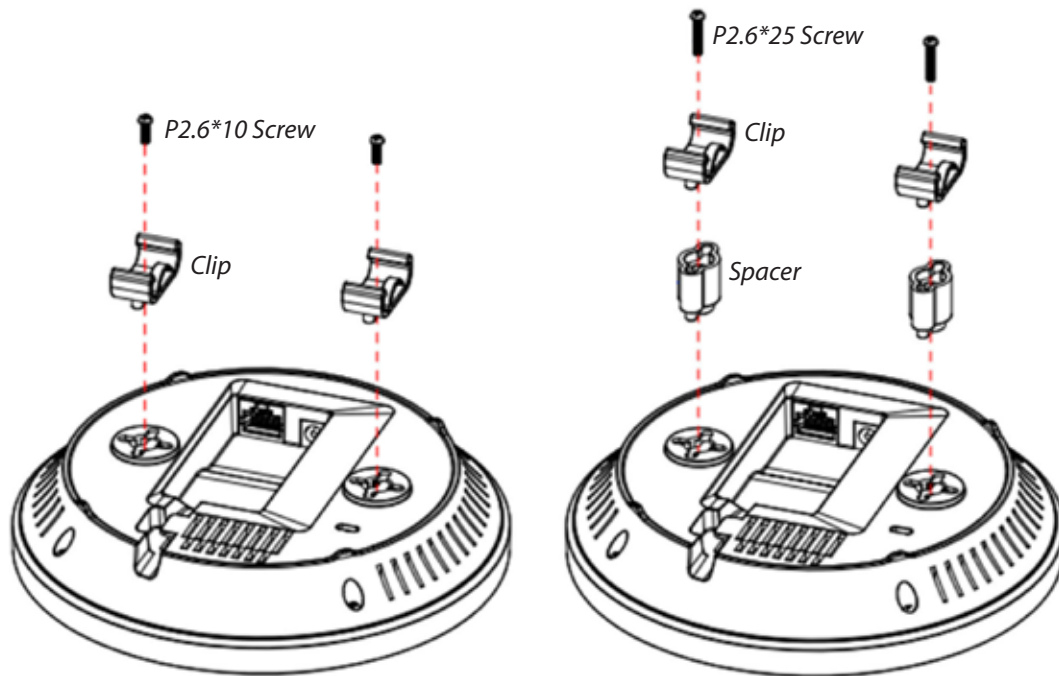

Chapter 3

Configuring Your Access Point



Configuring Your Access Point

This section will show you how to configure the device using the web-based configuration interface.

Default Settings

Please use your Ethernet port or wireless network adapter to connect the Access Point.

IP Address	192.168.1.1
Username/Password	admin/admin

Web Configuration

1. Open a web browser (Internet Explorer/Firefox/Safari) and enter the IP Address **http://192.168.1.1**.

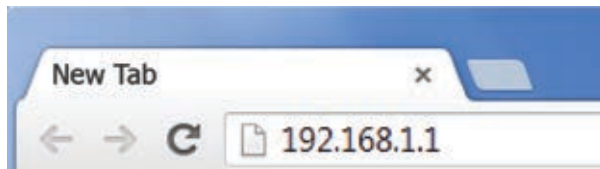

Note: If you have changed the default LAN IP Address of the Access Point, ensure you enter the correct IP Address.

2. The default username and password are: **admin**. Once you have entered the correct username and password, click the **Login** button to open the web-based configuration page.



3. If successful, you will be logged in and see the EAP900H User Menu.

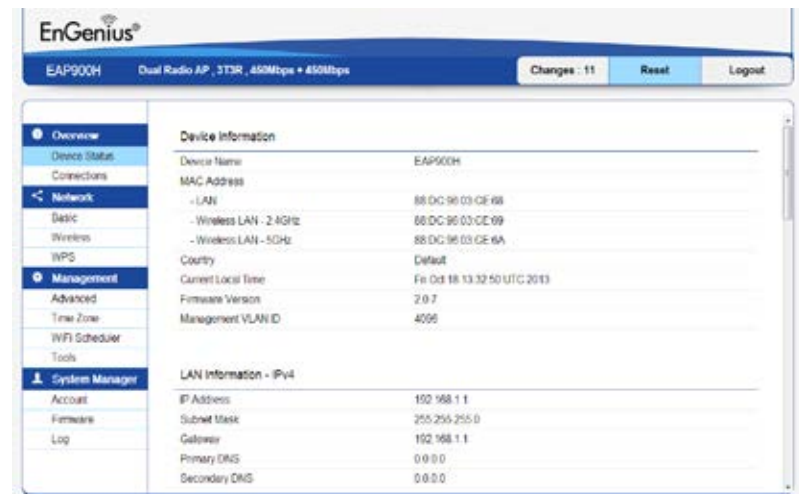

Chapter 4

Building a Wireless Network



The EAP900H has the ability to operate in various modes. This chapter describes the operating modes of the EAP900H.

Access Point Mode

In Access Point Mode, the EAP900H behaves like a central connection for stations or clients that support IEEE 802.11 a/b/g/n networks. The stations and clients must be configured to use the same SSID (Service Set Identifier) and security password to associate with the EAP900H. The EAP900H supports up to eight (8) SSIDs per band (16 total) at the same time for secure access.



WDS AP Mode

The EAP900H also supports WDS AP mode. This operating mode allows wireless connections to the EAP900H using WDS technology. In this mode, configure the MAC addresses in both Access Points to enlarge the wireless area by enabling WDS Link settings. WDS supports up to four (4) AP MAC addresses.

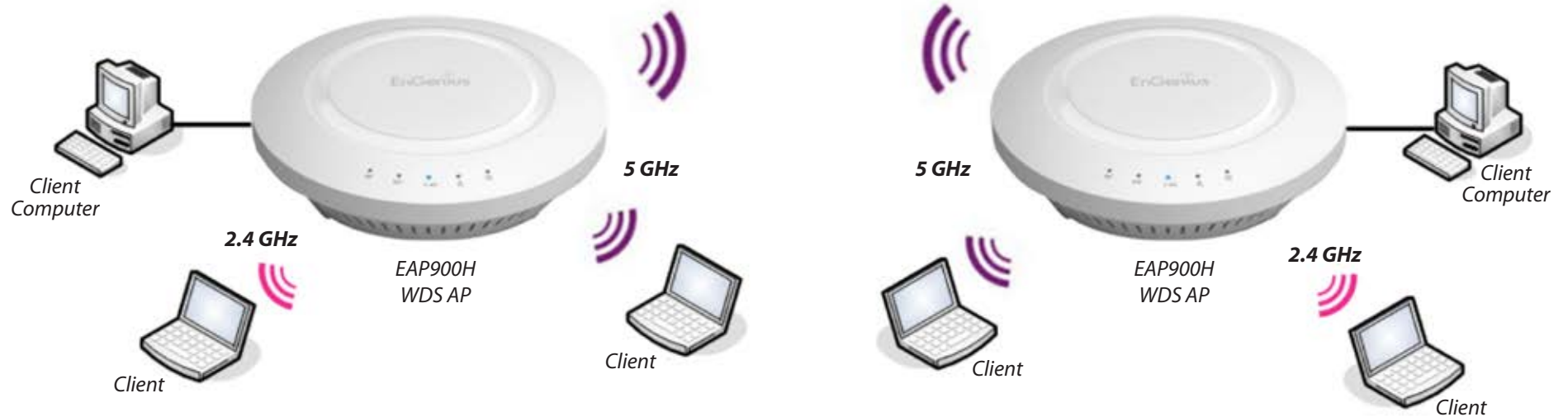

WDS Bridge Mode

In WDS Bridge Mode, the EAP900H can wirelessly connect different LANs by configuring the MAC address and security settings of each EAP900H device. Use this mode when two wired LANs located a small distance apart want to communicate with each other. The best solution is to use the EAP900H to wirelessly connect two wired LANs, as shown in the following figure.

WDS Bridge Mode can establish up to four (4) WDS links, creating a star-like network.

Note: WDS Bridge Mode does **not** act as an Access Point because Access Points linked by WDS use the same frequency channel. More Access Points connected together may lower throughput. This configuration can also be susceptible to generate endless network loops in your network, so it is recommended to enable the Spanning Tree function to prevent this from happening. You can find information about the Spanning Tree Function on page 31.

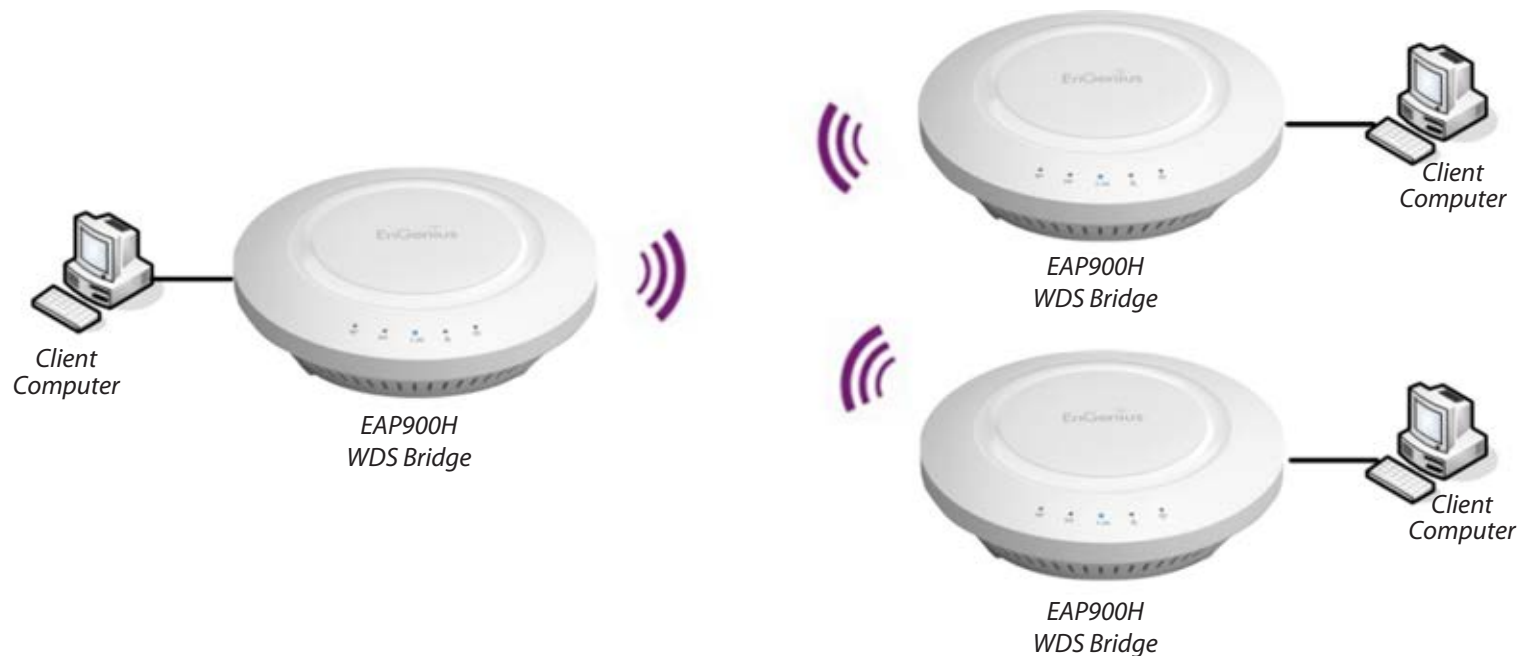

Chapter 5

Overview



Overview

The **Overview** section contains the following options:

- Device Status
- Connections

The following sections describe these options:



Device Status

Clicking the **Device Status** link under the **Overview** menu shows the status information about the current operating mode.

- The **Device Status** section shows general system information such as Device Name, MAC address, Current Time, Firmware Version, and Management VLAN ID

Note: VLAN ID is only applicable in Access Point or WDS AP mode.



- The **LAN Information** section under the **Connections** link shows the Local Area Network settings such as the LAN IP Address, Subnet mask, Gateway, DNS Address, DHCP Client, and STP status.

LAN Information - IPv4

IP Address	192.168.1.1
Subnet Mask	255.255.255.0
Gateway	192.168.1.1
Primary DNS	0.0.0.0
Secondary DNS	0.0.0.0
DHCP Client	Disable
Spanning Tree Protocol (STP)	Disable

- The **Current 2.4 GHz/5 GHz Wireless Settings** section under the **Basic** link shows wireless information such as Operating Mode, Frequency, and Channel. Since the EAP900H supports multiple-SSIDs, information about each SSID and security settings are displayed.

Note: Profile Settings is only applicable in Access Point or WDS AP mode.

Connections

The EAP900H automatically logs (records) events of possible interest in its internal memory. To view the logged information, click the **Connections** link under the **Device Status** menu. If there is not enough internal memory to log all events, older events are deleted from the log. When powered down or rebooted, the log will be cleared.

Click **Refresh** to refresh the Connections List page.

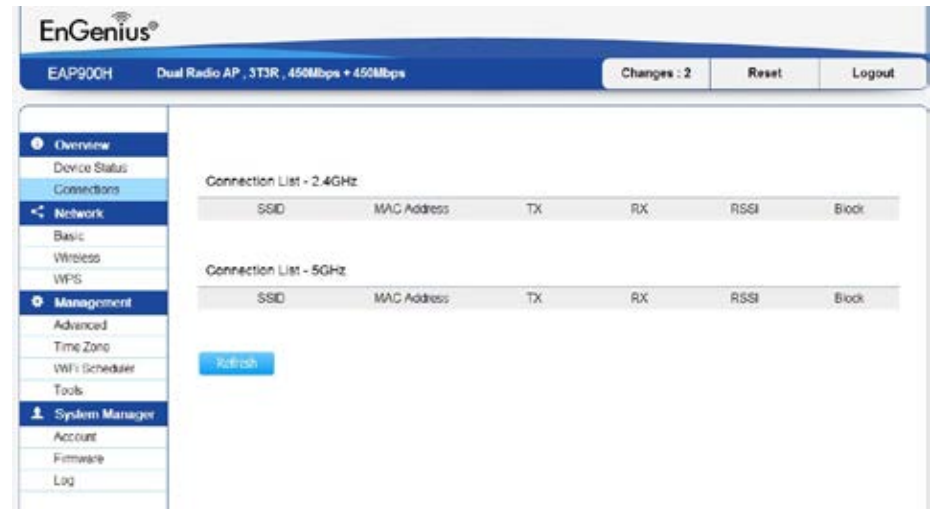

The screenshot shows the EnGenius EAP900H web interface. The top navigation bar includes the EnGenius logo, the device model 'EAP900H', and its specifications 'Dual Radio AP, 3T3R, 450Mbps + 450Mbps'. There are buttons for 'Changes: 2', 'Reset', and 'Logout'. The left sidebar menu is expanded to 'Connections' under the 'Device Status' section. The main content area shows two tables for connection lists. The first table is titled 'Connection List - 2.4GHz' and the second is 'Connection List - 5GHz'. Both tables have columns for SSID, MAC Address, TX, RX, RSSI, and Block. A blue 'Refresh' button is located below the 5GHz table.

Chapter 6

Network



Operation Modes

The EAP900H supports three operating modes:

Access Point, WDS AP, and WDS Bridge.

Device Settings



To access operation mode, click the **Wireless** section under Network in the sidebar. You will see wireless settings customizable options for both the 2.4 GHz and 5 GHz modes. Under Wireless settings, you will see:

Device Name: Enter a name for the device. The name you type appears in SNMP management. This name is not the SSID and is not broadcast to other devices.

Country/Region: Select a Country/Region to conform to local regulations.

Operation Mode: Use the radio button to select an operating mode.

Band Steering: Enable Band Steering to sends 802.11n clients to the 5 GHz band, where 802.11b/g clients cannot go, and leaves the 802.11b/g clients in 2.4 GHz to operate at their slower rates. Band Steering works within the Access Point by directing 5 GHz-capable clients to that band.

*Note: In order for the Band Steering function to work properly, both the 2.4 Ghz and the 5 GHz SSID and security settings must be under the same selection settings.

Basic

This page allows you to modify the device's IP settings.



IP Network Settings

Select whether the device IP address will use the static IP address specified in the IP Address field or be obtained automatically when the device connects to a DHCP server.

IP Address: The IP Address of this device.

IP Subnet Mask: The IP Subnet mask of this device.

Gateway: The Default Gateway of this device. Leave it blank if you are unsure of this setting.

Primary/Secondary DNS: The primary/secondary DNS address for this device.

Click **Save** to confirm the changes.

Spanning Tree Settings

This page allows you to modify the Spanning Tree settings. Enabling Spanning Tree protocol will prevent network loops in your LAN network.

Spanning Tree Protocol (STP) Settings

Status	Disable	
Hello Time	2	seconds (1-10)
Max Age	20	seconds (6-40)
Forward Delay	4	seconds (4-30)
Priority	32768	(0-65535)

Save current setting(s)

Spanning Tree Status: Enables or disables the Spanning Tree function.

Hello Time: Specify Bridge Hello Time, in seconds. This value determines how often the device sends handshake packets to communicate information about the topology throughout the entire Bridged Local Area Network.

Max Age: Specify Bridge Max Age, in seconds. If another bridge in the spanning tree does not send a hello packet for a long period of time, it is assumed to be inactive.

Forward Delay: Specifies Bridge Forward Delay, in seconds. Forwarding Delay Time is the time spent in each of the Listening and Learning states before the Forwarding state is entered. This delay is provided so that when a new bridge comes onto a busy network, it analyzes data traffic before participating.

Priority: Specify the Priority Number. A smaller number has greater priority.

Save: Click **Save** to confirm the changes.

Chapter 7

2.4GHz & 5GHz Wireless



Wireless Network

This page displays the current status of the Wireless settings of the EAP900H.

Access Point/WDS AP mode:

	2.4GHz	5GHz
Operation Mode	Access Point <input type="checkbox"/> Green	Access Point <input type="checkbox"/> Green
Wireless Mode	802.11 B/G/N	802.11 A/N
Channel HT Mode	20/40 MHz	40 MHz
Extension Channel	Upper Channel	Lower Channel
Channel	Auto	Auto
Transmit Power	Auto	Auto
Data Rate	Auto	Auto
RTS / CTS Threshold (1 - 2346)	2346	2346
Client Limits	127 <input type="checkbox"/> Enable	127 <input type="checkbox"/> Enable
Aggregation	Enable <input type="checkbox"/> 32 Frames 50000 Bytes(Max)	Enable <input type="checkbox"/> 32 Frames 50000 Bytes(Max)
AP Detection	<input type="button" value="Scan"/>	<input type="button" value="Scan"/>

Wireless Mode: Supports 802.11b/g/n mixed mode in 2.4GHz and 802.11a/n mixed mode in 5GHz.

Channel HT Mode: The default channel bandwidth is 20/40MHz. The larger the channel, the better the transmission quality and speed.

Extension Channel: Select **Upper** or **Lower** channel. Your selection may affect the Auto Channel function.

Channel/Frequency: Select the channel and frequency appropriate for your country's regulation.

Auto: Check this option to enable the Auto-Channel feature.

RTS/CTS Threshold: Specifies the threshold package size for RTS/CTS. A small number causes RTS/CTS packets to be sent more often and consumes more bandwidth.

Client Limits: Limits the total number of clients.

Aggregation: Merges data packets into one packet. This option reduces the number of packets, but also increases packet sizes.

AP Detection: AP Detection can select the best channel to use by scanning nearby areas for Access Points.

Current Profile: You can configure up to eight different SSIDs (4 in WDS AP mode). If multiple client devices will be accessing the network, you can arrange the devices into SSID groups. Click **Edit** to configure the profile and check whether you wish to enable extra SSIDs.

Save: Click **Save** to confirm the changes.

2.4GHz/5 GHz SSID Profile

Under **Wireless Settings**, you can edit the SSID profile to fit your needs. Click **Edit** under the SSID you would like to make changes to.

Wireless Settings - 2.4GHz

No	Enable	SSID	Edit	Security	Suppressed SSID	Station Separation	Isolation	VID
1	<input checked="" type="checkbox"/>	EnGenius03CE69_1-2.4GHz	Edit	None	<input type="checkbox"/>	<input type="checkbox"/>	<input type="checkbox"/>	1
2	<input type="checkbox"/>	EnGenius03CE69_2-2.4GHz	Edit	None	<input type="checkbox"/>	<input type="checkbox"/>	<input type="checkbox"/>	2
3	<input type="checkbox"/>	EnGenius03CE69_3-2.4GHz	Edit	None	<input type="checkbox"/>	<input type="checkbox"/>	<input type="checkbox"/>	3
4	<input type="checkbox"/>	EnGenius03CE69_4-2.4GHz	Edit	None	<input type="checkbox"/>	<input type="checkbox"/>	<input type="checkbox"/>	4
5	<input type="checkbox"/>	EnGenius03CE69_5-2.4GHz	Edit	None	<input type="checkbox"/>	<input type="checkbox"/>	<input type="checkbox"/>	5
6	<input type="checkbox"/>	EnGenius03CE69_6-2.4GHz	Edit	None	<input type="checkbox"/>	<input type="checkbox"/>	<input type="checkbox"/>	6
7	<input type="checkbox"/>	EnGenius03CE69_7-2.4GHz	Edit	None	<input type="checkbox"/>	<input type="checkbox"/>	<input type="checkbox"/>	7
8	<input type="checkbox"/>	EnGenius03CE69_8-2.4GHz	Edit	None	<input type="checkbox"/>	<input type="checkbox"/>	<input type="checkbox"/>	8

Wireless Settings - 5GHz

No	Enable	SSID	Edit	Security	Suppressed SSID	Station Separation	Isolation	VID
1	<input checked="" type="checkbox"/>	EnGenius03CE6A_1-5GHz	Edit	None	<input type="checkbox"/>	<input type="checkbox"/>	<input type="checkbox"/>	51
2	<input type="checkbox"/>	EnGenius03CE6A_2-5GHz	Edit	None	<input type="checkbox"/>	<input type="checkbox"/>	<input type="checkbox"/>	52
3	<input type="checkbox"/>	EnGenius03CE6A_3-5GHz	Edit	None	<input type="checkbox"/>	<input type="checkbox"/>	<input type="checkbox"/>	53
4	<input type="checkbox"/>	EnGenius03CE6A_4-5GHz	Edit	None	<input type="checkbox"/>	<input type="checkbox"/>	<input type="checkbox"/>	54

SSID: Specifies the SSID for the current profile.

Suppressed SSID: Check this option to hide the SSID from clients. If checked, the SSID will not appear in the site survey.

Station Separation: Click the appropriate button to allow or prevent communication between client devices.

Wireless Security: See the Wireless Security section on page 36.

Isolation: Check the box to **Enable** or **Disable** the Isolation feature.

Save: Click **Save** to accept the changes.

Wireless Security

The Wireless Security section lets you configure the EAP900H's security modes:

WEP

WPA-PSK

WPA2-PSK

WPA-PSK Mixed

WPA-Enterprise

WPA2-Enterprise

WPA Mixed Enterprise.

It is **strongly** recommended that you use WPA2-PSK. Click on the **Edit** button under Wireless Settings next to the SSID to change the security settings.

WEP Encryption:

The screenshot shows the 'Wireless Security - 2.4G' configuration page. The 'Security Mode' is set to 'WEP'. The 'Auth Type' is set to 'Open System'. The 'Input Type' is set to 'Hex'. The 'Key Length' is set to '40/64-bit (10 hex digits or 5 ASCII char)'. The 'Default Key' is set to '1'. There are four input fields for 'Key1', 'Key2', 'Key3', and 'Key4', all of which are currently empty.

Auth Type: Select **Open System** or **Shared Key**.

Input Type: ASCII: Regular Text (Recommended)

HEX: Hexadecimal Numbers (For advanced users)

Key Length: Select the desired option and ensure the wireless clients use the same setting. Your choices are: 64, 128, and 152-bit password lengths.

Default Key: Select the key you wish to be default. Transmitted data is **ALWAYS** encrypted using the Default Key; the other Keys are for decryption only. You must enter a Key Value for the Default Key.

Encryption Key: Enter the Key Value or values you wish to use. The default is none.

WPA-PSK (WPA Pre-Shared Key) Encryption:

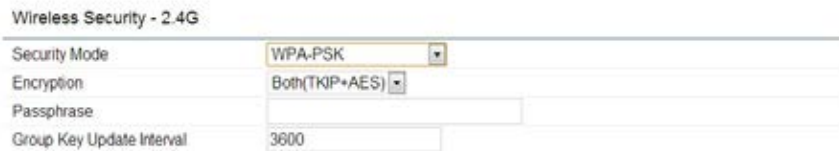

Wireless Security - 2.4G

Security Mode	WPA-PSK
Encryption	Both(TKIP+AES)
Passphrase	
Group Key Update Interval	3600

Encryption: Select the WPA encryption type you would like to use. Please ensure that your wireless clients use the same settings.

Passphrase: Wireless clients must use the same Key to associate the device. If using ASCII format, the Key must be from 8 to 63 characters in length. If using HEXformat, the Key must be 64 HEX characters in length.

Group Key Update Interval: Specify how often, in seconds, the Group Key changes.

WPA2-PSK Encryption:

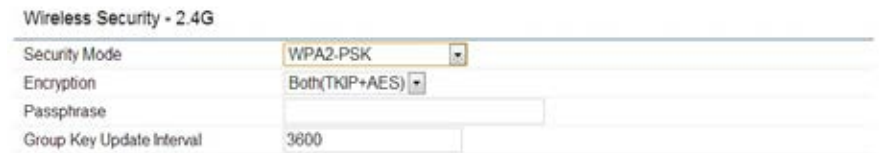

Wireless Security - 2.4G

Security Mode	WPA2-PSK
Encryption	Both(TKIP+AES)
Passphrase	
Group Key Update Interval	3600

Encryption: Select the WPA encryption type you would like to use. Please ensure that your wireless clients use the same settings.

Passphrase: Wireless clients must use the same Key to associate the device. If using ASCII format, the Key must be from 8 to 63 characters in length. If using HEXformat, the Key must be 64 HEX characters in length.

Group Key Update Interval: Specify how often, in seconds, the Group Key changes.

WPA-PSK Mixed Encryption:

Wireless Security - 2.4G	
Security Mode	WPA-PSK Mixed
Encryption	Both(TKIP+AES)
Passphrase	
Group Key Update Interval	3600

Encryption: Select the WPA encryption type you would like to use. Please ensure that your wireless clients use the same settings.

Passphrase: Wireless clients must use the same Key to associate the device. If using ASCII format, the Key must be from 8 to 63 characters in length. If using HEXformat, the Key must be 64 HEX characters in length.

Group Key Update Interval: Specify how often, in seconds, the group key changes.

WPA-Enterprise Encryption:

Wireless Security - 2.4G	
Security Mode	WPA-Enterprise
Encryption	Both(TKIP+AES)
Group Key Update Interval	3600
Radius Server	
Radius Port	1812
Radius Secret	
Radius Accounting	Disable
Radius Accounting Server	
Radius Accounting Port	1813
Radius Accounting Secret	
Interim Accounting Interval	600

Encryption: Select the WPA encryption type you would like. Please ensure that your wireless clients use the same settings.

Group Key Update Interval: Specify how often, in seconds, the group key changes.

Radius Server: Enter the IP address of the Radius server.

Radius Port: Enter the port number used for connections to the Radius server.

Radius Secret: Enter the secret required to connect to the Radius server.

Radius Accounting: Enables or disables the accounting feature.

Radius Accounting Server: Enter the IP address of the Radius accounting server.

Radius Accounting Port: Enter the port number used for connections to the Radius accounting server.

Radius Accounting Secret: Enter the secret required to connect to the Radius accounting server.

Interim Accounting Interval: Specify how often, in seconds, the accounting data sends.

Note: 802.11n does not allow WEP/WPA-PSK TKIP/WPA2-PSK TKIP security mode. The connection mode will automatically change from 802.11n to 802.11g.

WPA2Enterprise Encryption:

The screenshot shows the 'Wireless Security - 2.4G' configuration page. The settings are as follows:

Field	Value
Security Mode	WPA2-Enterprise
Encryption	Both(TKIP+AES)
Group Key Update Interval	3600
Radius Server	
Radius Port	1812
Radius Secret	
Radius Accounting	Disable
Radius Accounting Server	
Radius Accounting Port	1813
Radius Accounting Secret	
Interim Accounting Interval	600

Encryption: Select the WPA encryption type you would like. Please ensure that your wireless clients use the same settings.

Group Key Update Interval: Specify how often, in seconds, the group key changes.

Radius Server: Enter the IP address of the Radius server.

Radius Port: Enter the port number used for connections to the Radius server.

Radius Secret: Enter the secret required to connect to the Radius server.

Radius Accounting: Enables or disables the Radius accounting feature.

Radius Accounting Server: Enter the IP address of the Radius accounting server.

Radius Accounting Port: Enter the port number used for connections to the Radius accounting server.

Radius Accounting Secret: Enter the secret required to connect to the Radius accounting server.

Interim Accounting Interval: Specify how often, in seconds, the accounting data sends.

Note: 802.11n does not allow WEP/WPA-PSK TKIP/WPA2-PSK TKIP security mode. The connection mode will automatically change from 802.11n to 802.11g.

WPA Mixed Enterprise Encryption:

Wireless Security - 2.4G

Security Mode	WPA Mixed-Enterprise ▾
Encryption	Both(TKIP+AES) ▾
Group Key Update Interval	3600
Radius Server	
Radius Port	1812
Radius Secret	
Radius Accounting	Disable ▾
Radius Accounting Server	
Radius Accounting Port	1813
Radius Accounting Secret	
Interim Accounting Interval	600

Encryption: Select the WPA encryption type you would like. Please ensure that your wireless clients use the same settings.

Group Key Update Interval: Specify how often, in seconds, the group key changes.

Radius Server: Enter the IP address of the Radius server.

Radius Port: Enter the port number used for connections to the Radius server.

Radius Secret: Enter the secret required to connect to the Radius server.

Radius Accounting: Enables or disables the Radius accounting feature.

Radius Accounting Server: Enter the IP address of the Radius accounting server.

Radius Accounting Port: Enter the port number used for connections to the Radius accounting server.

Radius Accounting Secret: Enter the secret required to connect to the Radius accounting server.

Interim Accounting Interval: Specify how often, in seconds, the accounting data sends.

Note: 802.11n does not allow WEP/WPA-PSK TKIP/WPA2-PSK TKIP security mode. The connection mode will automatically change from 802.11n to 802.11g.

Wireless MAC Filtering

Wireless MAC Filtering is used to allow or deny network access to wireless clients (computers, tablet PCs, NAS, smartphones, etc.) according to their MAC addresses. You can manually add a MAC address to restrict permission to access EAP900H. The default setting is: **Disable Wireless MAC Filter**.

Note: Only applicable in Access Point and WDS AP mode.

Wireless MAC Filter

ACL Mode: Disabled

MAC Address: [] : [] : [] : [] : [] : [] Add

No.	MAC Address
-----	-------------

ACL (Access Control List) Mode: Determines whether network access is granted or denied to clients whose MAC addresses appear in the MAC address table on this page. Choices given are: Disabled, Deny MAC in the list, or Allow MAC in the list.

MAC Address: Enter the MAC address of the wireless client.

Add: Click **Add** to add the MAC address to the MAC Address table.

Delete: Deletes the selected entries.

Save: Click **Save** to apply the changes.

Wireless Advanced

This page allows you to configure wireless advanced settings. It is recommended that the default settings are used unless the user has experience with more advanced networking features.

2.4 GHz/5 GHz Wireless Advanced

	2.4GHz	5GHz
Operation Mode	Access Point <input type="checkbox"/> Green <input checked="" type="checkbox"/>	Access Point <input type="checkbox"/> Green <input checked="" type="checkbox"/>
Wireless Mode	802.11 B/G/N	802.11 A/N
Channel HT Mode	20/40 MHz	40 MHz
Extension Channel	Upper Channel	Lower Channel
Channel	Auto	Auto
Transmit Power	Auto	Auto
Data Rate	Auto	Auto
RTS / CTS Threshold (1 - 2346)	2346	2348
Client Limits	127 <input type="checkbox"/> Enable <input checked="" type="checkbox"/>	127 <input type="checkbox"/> Enable <input checked="" type="checkbox"/>
Aggregation	Enable <input checked="" type="checkbox"/> 32 Frames	Enable <input checked="" type="checkbox"/> 32 Frames
	50000 Bytes(Max)	50000 Bytes(Max)
AP Detection	<input type="button" value="Scan"/>	<input type="button" value="Scan"/>

Data Rate: Select a data rate from the drop-down list. The data rate affects throughput of data in the EAP900H. The lower the data rate, the lower the throughput, though transmission distance will be lowered as well.

Transmit Power: Set the power output of the wireless signal.

RTS/CTS Threshold: Specify the threshold package size for RTC/CTS. A smaller number causes RTS/CTS packets to be sent more often and in turn consumes more bandwidth.

Distance: Specify the distance between Access Points and clients. Longer distances may drop high-speed connections.

Aggregation: Merges data packets into one packet. This option reduces the number of packets, but increases packet sizes.

Save: Click **Save** to confirm the changes.

WPS (Wi-Fi Protected Setup)

The Wi-Fi Protected Setup (WPS) feature complies with the Wi-Fi Alliance WPS standard and makes it easier to quickly add client devices to an established, security-enabled Wi-Fi network.

WPS reduces the user steps required to configure a network and supports two methods that are familiar to most consumers to configure a network and enable security.

Note: Only applicable in Access Point and WDS AP mode.

WPS (Wi-Fi Protected Setup)

WPS Settings - 2.4GHz

Status	Disable
Current Configuration	Configured <input type="button" value="Release Configuration"/>
Self Pin Code	45358647
SSID	EnGenius03CE69_1-2.4GHz
Authentication Mode	None
Encryption Key	None
WPS via Push Button	<input type="button" value="Start"/>
WPS via Pin	<input type="text"/> <input type="button" value="Start"/>

WPS: Select to **Enable** or **Disable** the WPS feature.

WPS Current Status: Shows whether the WPS function is

Configured or **Unconfigured**. When it is configured, the WPS has been used to authorize a connection between the device and wireless clients.

Self Pin Code: The PIN code of this device.

SSID: The SSID (wireless network name) used when connecting using WPS.

Authentication Mode: Shows the encryption method used by the WPS process.

Passphrase Key: This is the passphrase key that is randomly generated during the WPS process. It is required if wireless clients that do not support WPS attempt to connect to the wireless network.

WPS via Push Button: Click this button to initialize the WPS feature using the **Push Button** method.

WPS via PIN: Enter the PIN code of the wireless device and click this button to initialize WPS feature using the PIN method.

Save: Click **Save** to confirm the changes.

WDS Link Settings

Using WDS (Wireless Distribution System) will allow a network administrator or installer to connect to Access Points wirelessly. Doing so will extend the wired infrastructure to locations where cabling is not possible or inefficient to implement.

Note: Compatibility between different brands and models of Access Points is not guaranteed. It is recommended that the WDS network be created using the same models for maximum compatibility.

Also Note: All Access Points in the WDS network must use the same Channel and Security settings.

To create a WDS network, please enter the MAC addresses of the Access Points that you want included in the WDS. There can be a maximum of four Access Points.

Note: Only applicable in WDS AP and WDS Bridge modes.

2.4 GHz/5 GHz WDS Link Settings

ID	MAC Address	Mode
1		Disable
2		Disable
3		Disable
4		Disable

Security: Select None or AES from the drop-down list.

AES Passphrase: Enter the Key Values you wish to use. Other AP(s) must use the same key to establish WDS link.

MAC Address: Enter the Access Point's MAC address to which you want to extend the wireless area.

Mode: Select **Disable** or **Enable** from the drop-down list.

Save: Click **Save** to confirm the changes.

Chapter 8

Management



Administration

This page allows you to change the EAP900H username and password. By default, the username is **admin** and the password is **admin**. The password can contain from 0 to 12 alphanumeric characters and is **case sensitive**.

Username: **admin**

Password: **admin**

Account Setting

Account Settings	
Administrator Username	admin
Current Password	
New Password	
Verify Password	

Apply saved settings to take effect

New Name: Enter a new username for logging in to the New Name entry box.

Old Password: Enter the old password for logging in to the Old Password entry box.

New Password: Enter the new password for logging in to the New Password entry box.

Confirm Password: Re-enter the new password in the Confirm Password entry box for confirmation.

Apply: Click **Apply** to save the changes.

Note: it is highly recommended that you change your password to something more unique for greater security.

Management VLAN Settings

This page allows you to assign a VLAN tag to the packets. A VLAN is a group of computers on a network whose software has been configured so that they behave as if they were on a separate Local Area Network (LAN). Computers on VLAN do not have to be physically located next to one another on the LAN.

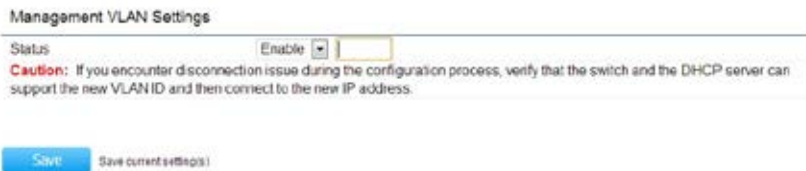

Management VLAN Settings

Status: Enable

Caution: If you encounter disconnection issue during the configuration process, verify that the switch and the DHCP server can support the new VLAN ID and then connect to the new IP address.

Save current settings

To configure VLAN tags, you must first Isolate and enter a VID before enabling VLAN under Management VLAN ID.

Note: Only applicable in Access Point and WDS AP mode.

Profile Isolation: Restrict clients from communicating with different VIDs by checking the Isolation box for the SSID you wish to select under the Wireless Settings function.

No.	Enable	SSID	Edit	Security	Suppressed SSID	Station Separation	Isolation	VID
1	<input checked="" type="checkbox"/>	EnGenius03CE69_1-2.4GHz	<input type="button" value="Edit"/>	None	<input type="checkbox"/>	<input type="checkbox"/>	<input type="checkbox"/>	1
2	<input type="checkbox"/>	EnGenius03CE69_2-2.4GHz	<input type="button" value="Edit"/>	None	<input type="checkbox"/>	<input type="checkbox"/>	<input type="checkbox"/>	2
3	<input type="checkbox"/>	EnGenius03CE69_3-2.4GHz	<input type="button" value="Edit"/>	None	<input type="checkbox"/>	<input type="checkbox"/>	<input type="checkbox"/>	3
4	<input type="checkbox"/>	EnGenius03CE69_4-2.4GHz	<input type="button" value="Edit"/>	None	<input type="checkbox"/>	<input type="checkbox"/>	<input type="checkbox"/>	4
5	<input type="checkbox"/>	EnGenius03CE69_5-2.4GHz	<input type="button" value="Edit"/>	None	<input type="checkbox"/>	<input type="checkbox"/>	<input type="checkbox"/>	5
6	<input type="checkbox"/>	EnGenius03CE69_6-2.4GHz	<input type="button" value="Edit"/>	None	<input type="checkbox"/>	<input type="checkbox"/>	<input type="checkbox"/>	6
7	<input type="checkbox"/>	EnGenius03CE69_7-2.4GHz	<input type="button" value="Edit"/>	None	<input type="checkbox"/>	<input type="checkbox"/>	<input type="checkbox"/>	7
8	<input type="checkbox"/>	EnGenius03CE69_8-2.4GHz	<input type="button" value="Edit"/>	None	<input type="checkbox"/>	<input type="checkbox"/>	<input type="checkbox"/>	8

No.	Enable	SSID	Edit	Security	Suppressed SSID	Station Separation	Isolation	VID
1	<input checked="" type="checkbox"/>	EnGenius03CE6A_1-5GHz	<input type="button" value="Edit"/>	None	<input type="checkbox"/>	<input type="checkbox"/>	<input type="checkbox"/>	51
2	<input type="checkbox"/>	EnGenius03CE6A_2-5GHz	<input type="button" value="Edit"/>	None	<input type="checkbox"/>	<input type="checkbox"/>	<input type="checkbox"/>	52
3	<input type="checkbox"/>	EnGenius03CE6A_3-5GHz	<input type="button" value="Edit"/>	None	<input type="checkbox"/>	<input type="checkbox"/>	<input type="checkbox"/>	53

VLAN ID (VID): Specifies the VLAN tag for each profile.

Management VLAN ID: If your network includes VLANs, you can specify a VLAN ID for packets pass through the Access Point with a tag. Otherwise, select no VLAN tag.

Save: Click **Save** to confirm the changes.

Note:

1. If you reconfigure the Management VLAN ID, you may lose your connection to the EAP900H. Verify that the DHCP server supports the reconfigured VLAN ID, then reconnect to the EAP900H using the new IP address.

Wireless Traffic Shaping

Traffic Shaping regulates the flow of packets leaving an interface to deliver improved Quality of Service. To edit Wireless Traffic Shaping, click **Edit** for the SSID you would like to configure under Wireless Settings.



The screenshot shows a configuration window titled "Wireless Traffic Shaping". It contains three rows of settings:

Wireless Traffic Shaping		
Enable Traffic Shaping	Disable ▾	
Download Limit	100	Mbps (1-999)
Upload Limit	100	Mbps (1-999)

At the bottom left, there is a blue "Save" button with the text "Save current setting(s)" next to it.

Enable Traffic Shaping: select this option from the drop-down box to enable Wireless Traffic Shaping.

Download Limit: Specifies the wireless transmission speed used for downloading.

Upload Limit: Specifies the wireless transmission speed used for uploading.

Save: Click **Save** to confirm the changes.

SNMP Settings

This page allows you to assign the Contact Details, Location, Community Name, and Trap Settings for Simple Network Management Protocol (SNMP). This is a networking management protocol used to monitor network attached devices. SNMP allows messages (called protocol data units) to be sent to various parts of the network. Upon receiving these messages, SNMP compatible devices (called agents) returns the data stored in their Management Information Bases. To configure SNMP Settings, click under the **Advanced** tab on the side bar under Management.

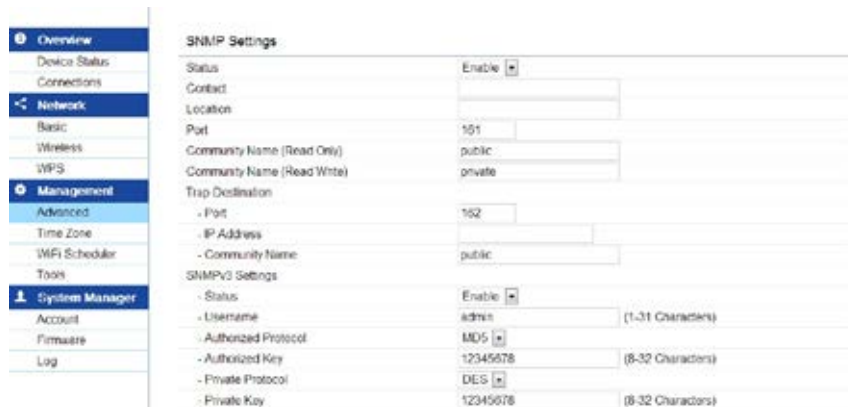

SNMP Settings	
Status	Enable
Contact	
Location	
Port	101
Community Name (Read Only)	public
Community Name (Read Write)	private
Trap Destination	
- Port	162
- IP Address	
- Community Name	public

SNMPv3 Settings	
Status	Enable
- Username	admin (1-31 Characters)
- Authorized Protocol	MD5
- Authorized Key	12345678 (8-32 Characters)
- Private Protocol	DES
- Private Key	12345678 (8-32 Characters)

Status: Enables or Disables the SNMP feature.

Contact: Specifies the contact details of the device.

Location: Specifies the location of the device.

Port: Displays the port number.

Community Name (Read Only): Specifies the password for the SNMP community for read only access.

Community Name (Read/Write): Specifies the password for the SNMP community with read/write access.

Trap Destination Address: Specifies the port and IP address of the computer that will receive the SNMP traps.

Trap Destination Community Name: Specifies the password for the SNMP trap community.

SNMPv3 Status: Enables or Disables the SNMPv3 feature.

User Name: Specifies the username for the SNMPv3 feature

Auth Protocol: Select the Authentication Protocol type: MDS or SHA.

AuthKey: Specify the Authentication Key for authentication.

Priv Protocol: Select the Privacy Protocol type: **DES**.

Priv Key: Specifies the privacy key for privacy.

Engine ID: Specifies the Engine ID for SNMPv3.

Save: Click **Save** to apply the changes.

Backup/Restore

This page allows you to save the current device configurations. When you save the configurations, you can also reload the saved configurations into the device through the Restore Saved Settings from a file folder. If extreme problems occur, or if you have set the EAP900H incorrectly, you can use the Factory Default button in the Revert to Factory Default Settings section to restore all the configurations of the EAP900H to the original default settings. To Configure the Backup/Restore Settings, click **Firmware** under the Systems Manager tab.

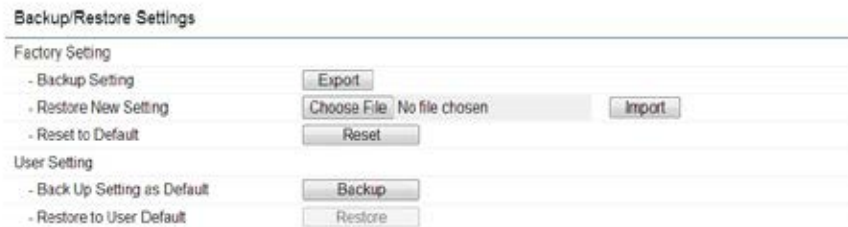

Factory Settings

Backup Settings: To restore settings that have been previously backed up, click **Export**, select the file, and click **Restore**.

Restore New Setting: Choose the file you wish restore for settings and click **Import**.

Reset to Default: Click the **Reset** button to restore the EAP900H to its factory default settings.

User Settings

Back Up Setting as Default: Click **Backup** to backup the user settings you would like to use as the default settings.

Restore to User Default: Click **Restore** to restore user settings to the factory standard settings.

Auto Reboot Settings

You can specify how often you would like to reboot the EAP900H. To configure the Auto Reboot settings, click the *Wi-Fi Scheduler* tab on the side bar under *Management*.

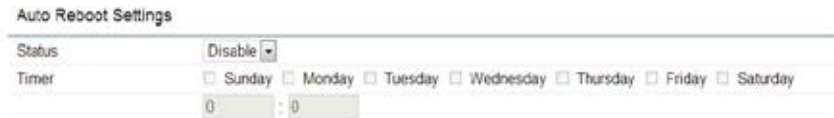

The screenshot shows the 'Auto Reboot Settings' form. It includes a 'Status' dropdown menu set to 'Disable', a 'Timer' section with checkboxes for each day of the week (Sunday through Saturday), and two input fields for time and frequency, both currently set to '0'.

Auto Reboot Settings	
Status	Disable ▾
Timer	<input type="checkbox"/> Sunday <input type="checkbox"/> Monday <input type="checkbox"/> Tuesday <input type="checkbox"/> Wednesday <input type="checkbox"/> Thursday <input type="checkbox"/> Friday <input type="checkbox"/> Saturday
	0 : 0

Auto Reboot Setting: Enables or disables the Auto Reboot function.

Frequency of Auto Reboot: Specifies the time and frequency in rebooting the EAP900H by Min, Hour, Day and/or Week.

Click **Save** to apply the changes.

Firmware Upgrade

This page allows you to upgrade the Firmware of the EAP900H.



Firmware Upgrade

Current Firmware Version: 2.0.7

Select the new firmware from your hard disk

No file chosen

To Perform the Firmware Upgrade:

1. Click the **Choose File** button and navigate the OS File System to the location of the Firmware upgrade file.
2. Select the upgrade file. The name of the file will appear in the Upgrade File field.
3. Click the **Upload** button to commence the Firmware upgrade.

Note: The device is unavailable during the upgrade process and must restart when the upgrade is completed. Any connections to or through the device will be lost.

Date and Time Settings

This page allows you to set the internal clock of the EAP900H. To access the Date and Time settings, click **Time Zone** under the Management tab on the side bar.

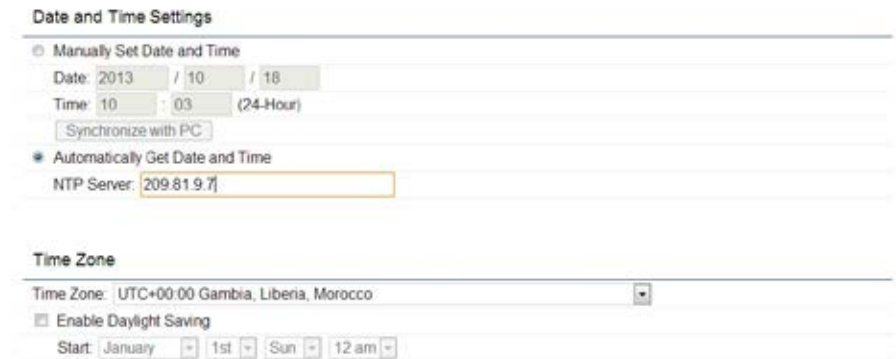

Date and Time Settings

Manually Set Date and Time

Date: 2013 / 10 / 18

Time: 10 : 03 (24-Hour)

Automatically Get Date and Time

NTP Server: 209.81.9.7

Time Zone

Time Zone: UTC+00:00 Gambia, Liberia, Morocco

Enable Daylight Saving

Start: January 1st Sun 12 am

Manually Set Date and Time: Manually specify the date and time.

Synchronize with PC: Click to Synchronize the EAP900H with the computer's internal clock.

Automatically Get Date and Time: Enter the IP address of an NTP server or use the default NTP server to have the internal clock set automatically.

Time Zone: Choose the time zone you would like to use from the drop-down list.

Enable Daylight Savings: Check the box to enable or

disable daylight savings time for the EAP900H. Next, enter the dates that correspond to the present year's daylight savings time.

Click **Apply** to save the changes.

would like to remote to.

Log Server IP Address: Enter the IP address of the log server.

Apply: Click **Apply** to save the changes.

System Log

This page allows you to setup the System Log and local log functions of the EAP900H. Click **Log** under the Systems Manager tab to open up the System Log page.

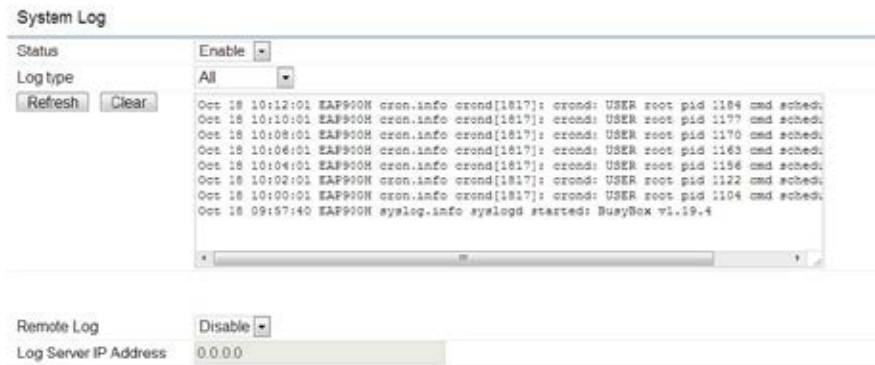

System Log

Status:

Log type:

```
Oct 18 10:12:01 EAP900H cron.info crond[1817]: crond: USER root pid 1184 cmd echoed
Oct 18 10:10:01 EAP900H cron.info crond[1817]: crond: USER root pid 1177 cmd echoed
Oct 18 10:08:01 EAP900H cron.info crond[1817]: crond: USER root pid 1170 cmd echoed
Oct 18 10:06:01 EAP900H cron.info crond[1817]: crond: USER root pid 1163 cmd echoed
Oct 18 10:04:01 EAP900H cron.info crond[1817]: crond: USER root pid 1156 cmd echoed
Oct 18 10:02:01 EAP900H cron.info crond[1817]: crond: USER root pid 1122 cmd echoed
Oct 18 10:00:01 EAP900H cron.info crond[1817]: crond: USER root pid 1104 cmd echoed
Oct 18 09:57:40 EAP900H syslog.info syslogd started: BusyBox v1.19.4
```

Remote Log:

Log Server IP Address:

Status: Enables or disables the System Log function.

Log Type: Select the Log Type mode you would like to use.

Remote Log: Enables or disables the Remote Log feature. If enabled, enter the IP address of the Log you

Tools

This page allows you to analyze the connection quality of the EAP900H and trace the routing table to a target in the network.

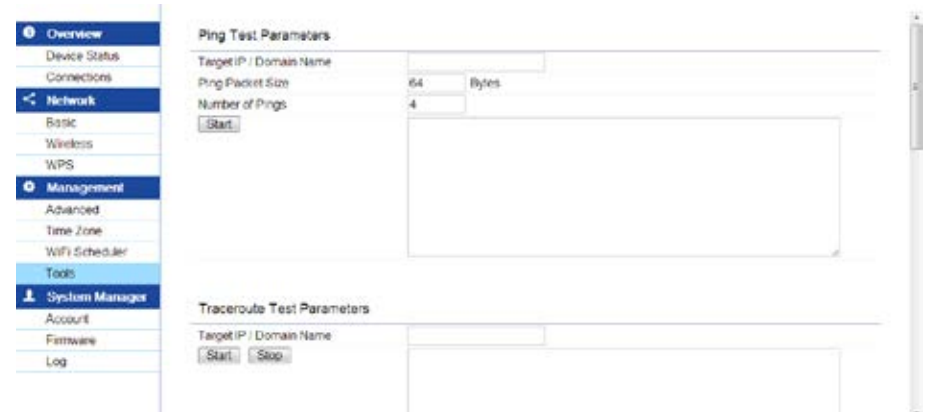

Overview

Device Status

Connections

Network

Basic

Wireless

WPS

Management

Advanced

Time Zone

WiFi Scheduler

Tools

System Manager

Account

Firmware

Log

Ping Test Parameters

Target IP / Domain Name:

Ping Packet Size: Bytes

Number of Pings:

Traceroute Test Parameters

Target IP / Domain Name:

Ping Test Parameters

Target IP/Domain Name: Enter the IP address you would like to search.

Ping Packet Size: Enter the packet size of each ping.

Number of Pings: Enter the number of times you wish to ping.

Start Ping: Click **Start Ping** to begin pinging target device (via IP).

Traceroute Parameters

Target IP/Domain Name: Enter an IP address or domain name you wish to trace.

Start: Click **Start** to begin the trace route operation.

Stop: Halts the traceroute test.

Ping Test Parameters

Target IP / Domain Name		
Ping Packet Size	64	Bytes
Number of Pings	4	
<input type="button" value="Start"/>		

Traceroute Test Parameters

Target IP / Domain Name	192.168.1.88
<input type="button" value="Start"/> <input type="button" value="Stop"/>	
traceroute to 192.168.1.88 (192.168.1.88), 30 hops max, 38 byte packets	
1 192.168.1.88 (192.168.1.88) 0.209 ms	

Speed Test Parameters

Target IP/Domain Name: Enter an IP address or domain name you wish to run a Speed Test for.

Time Period/Check Interval: Enter the time in seconds that you would like the test to run for and in how many intervals.

Start: Starts the Speed Test.

The screenshot shows a web interface titled "Speed Test Parameters". It contains several input fields and a button:

Target IP / Domain Name	<input type="text"/>	
Time Period	20	sec
Check Interval	5	sec
<input type="button" value="Start"/>	<div style="border: 1px solid #ccc; height: 100px; width: 100%;"></div>	
IPv4 Port	5001	
IPv6 Port	5002	

LED Control

This page allows you to control the LED control functions: Power status, LAN interface, 2.4G/5G WLAN interface and WPS.

Click **Apply** to save the settings after selecting your choices from the drop-down boxes.

The screenshot shows a web interface titled "LED Control". It contains several dropdown menus and an apply button:

Power	Enable
LAN	Enable
WLAN-2.4GHz	Enable
WLAN-5GHz	Enable
WPS	Enable
<input type="button" value="Apply"/>	Apply saved settings to take effect

Device Discovery

Under Device Discovery, you can choose for the EAP900H to Automatically scan for local devices to connect to. Click **Scan** to begin the process.

Device Discovery

Device Name	Operation Mode	IP Address	System MAC Address	Firmware Version
<input type="button" value="Scan"/>				

Reset

In some circumstances, you may be required to force the device to reboot. Click on **Reboot the Device** to reboot the EAP900H.

The screenshot shows the EnGenius web interface for an EAP900H device. The header includes the EnGenius logo and device information: "EAP900H Dual Radio AP, 3T3R, 450Mbps + 450Mbps". On the right side of the header, there are three buttons: "Changes : 2", "Reset", and "Logout". Below the header, a navigation menu on the left shows "Overview" (with an information icon) and "Device Status". The main content area displays "Firmware Upgrade".

Appendix



Appendix A

Federal Communication Commission Interference Statement

This equipment has been tested and found to comply with the limits for a Class B digital device, pursuant to Part 15 of the FCC Rules. These limits are designed to provide reasonable protection against harmful interference in a residential installation. This equipment generates, uses, and can radiate radio frequency energy and, if not installed and used in accordance with the instructions, may cause harmful interference to radio communications. However, there is no guarantee that interference will not occur in a particular installation. If this equipment does cause harmful interference to radio or television reception, which can be determined by turning the equipment off and on, the user is encouraged to try to correct the interference by one of the following measures:

- Reorient or relocate the receiving antenna.
- Increase the separation between the equipment and receiver.
- Connect the equipment into an outlet on a circuit different from that to which the receiver is connected.
- Consult the dealer or an experienced radio/TV technician for help.



FCC Caution:

Any changes or modifications not expressly approved by the party responsible for compliance could void the user's authority to operate this equipment.

This device complies with Part 15 of the FCC Rules. Operation is subject to the following two conditions: (1) This device may not cause harmful interference, and (2) this device must accept any interference received, including interference that may cause undesired operation.

This transmitter must not be co-located or operating in conjunction with any other antenna or transmitter. Operations in the 5.15-5.25 GHz band are restricted to indoor usage only.

IMPORTANT NOTE: Radiation Exposure Statement

This equipment complies with FCC radiation exposure limits set forth for an uncontrolled environment. This equipment should be installed and operated with a minimum distance of 23 cm between the radiator & your body.

Appendix B - IC Interference Statement

Industry Canada Statement

This device complies with RSS-210 of the Industry Canada Rules. Operation is subject to the following two conditions: (1) This device may not cause harmful interference, and (2) this device must accept any interference received, including interference that may cause undesired operation.

Ce dispositif est conforme à la norme CNR-210 d'Industrie Canada applicable aux appareils radio exempts de licence. Son fonctionnement est sujet aux deux conditions suivantes: (1) le dispositif ne doit pas produire de brouillage préjudiciable, et (2) ce dispositif doit accepter tout brouillage reçu, y compris un brouillage susceptible de provoquer un fonctionnement indésirable.



Caution:

- (i) the device for operation in the band 5150-5250 MHz is only for indoor use to reduce the potential for harmful interference to co-channel mobile satellite systems;
- (ii) high-power radars are allocated as primary users (i.e. priority users) of the bands 5250-5350 MHz and 5650-5850 MHz and that these radars could cause interference and/or damage to LE-LAN devices.



Avertissement:

- (i) les dispositifs fonctionnant dans la bande 5150-5250 MHz sont réservés uniquement pour une utilisation à l'intérieur afin de réduire les risques de brouillage préjudiciable aux systèmes de satellites mobiles utilisant les mêmes canaux;
- (ii) De plus, les utilisateurs devraient aussi être avisés que les utilisateurs de radars de haute puissance sont désignés utilisateurs principaux (c.-à-d., qu'ils ont la priorité) pour les bandes 5250-5350 MHz et 5650-5850 MHz et que ces radars pourraient causer du brouillage et/ou des dommages aux dispositifs LAN-EL.

FOR MOBILE DEVICE USAGE Radiation Exposure Statement

This equipment complies with IC radiation exposure limits set forth for an uncontrolled environment. This equipment should be installed and operated with a minimum distance of 20cm between the radiator & your body.

Pour l'utilisation de dispositifs mobiles) Déclaration d'exposition aux radiations:

Cet équipement est conforme aux limites d'exposition aux rayonnements IC établies pour un environnement non contrôlé. Cet équipement doit être installé et utilisé avec un minimum de 20cm de distance entre la source de rayonnement et votre corps.

Appendix C - CE Interference Statement

Europe - EU Declaration of Conformity

This device complies with the essential requirements of the R&TTE Directive 1999/5/EC. The following test methods have been applied in order to prove presumption of conformity with the essential requirements of the R&TTE Directive 1999/5/EC:

- **EN60950-1**
Safety of Information Technology Equipment
- **EN50385**
Generic standard to demonstrate the compliance of electronic and electrical apparatus with the basic restrictions related to human exposure to electromagnetic fields (0 Hz - 300 GHz)
- **EN 300 328**
Electromagnetic compatibility and Radio spectrum Matters (ERM); Wideband Transmission systems; Data transmission equipment operating in the 2,4 GHz ISM band and using spread spectrum modulation techniques; Harmonized EN covering essential requirements under article 3.2 of the R&TTE Directive
- **EN 301 893**
Broadband Radio Access Networks (BRAN); 5 GHz high performance RLAN; Harmonized EN covering essential requirements of article 3.2 of the R&TTE Directive
- **EN 301 489-1**
Electromagnetic compatibility and Radio Spectrum Matters (ERM); ElectroMagnetic Compatibility (EMC) standard for radio equipment and services; Part 1: Common technical requirements
- **EN 301 489-17**
Electromagnetic compatibility and Radio spectrum Matters (ERM); ElectroMagnetic Compatibility (EMC) standard for radio equipment and services; Part 17: Specific conditions for 2,4 GHz wideband transmission systems and 5 GHz high performance RLAN equipment

This device is a 5GHz wideband transmission system (transceiver), intended for use in all EU member states and EFTA countries, except in France and Italy where restrictive use applies.

In Italy the end-user should apply for a license at the national spectrum authorities in order to obtain authorization to use the device for setting up outdoor radio links and/or for supplying public access to telecommunications and/or network services.

This device may not be used for setting up outdoor radio links in France and in some areas the RF output power may be limited to 10 mW EIRP in the frequency range of 2454 – 2483.5 MHz. For detailed information the end-user should contact the national spectrum authority in France.

CE 0560

Česky [Czech]	[Jméno výrobce] tímto prohlašuje, že tento [typ zařízení] je ve shodě se základními požadavky a dalšími příslušnými ustanoveními směrnice 1999/5/ES.
Dansk [Danish]	Undertegnede [fabrikantens navn] erklærer herved, at følgende udstyr [udstyrets typebetegnelse] overholder de væsentlige krav og øvrige relevante krav i direktiv 1999/5/EF.
Deutsch [German]	Hiermit erkläre [Name des Herstellers], dass sich das Gerät [Gerätetyp] in Übereinstimmung mit den grundlegenden Anforderungen und den übrigen einschlägigen Bestimmungen der Richtlinie 1999/5/EG befindet.
Eesti [Estonian]	Käesolevaga kinnitab [tootja nimi = name of manufacturer] seadme [seadme tüüp = type of equipment] vastavust direktiivi 1999/5/EÜ põhinõuetele ja nimetatud direktiivist tulenevatele teistele asjakohastele sätetele.
English	Hereby, [name of manufacturer], declares that this [type of equipment] is in compliance with the essential requirements and other relevant provisions of Directive 1999/5/EC.
Español [Spanish]	Por medio de la presente [nombre del fabricante] declara que el [clase de equipo] cumple con los requisitos esenciales y cualesquiera otras disposiciones aplicables o exigibles de la Directiva 1999/5/CE.
Ελληνική [Greek]	ΜΕ ΤΗΝ ΠΑΡΟΥΣΑ [name of manufacturer] ΔΗΛΩΝΕΙ ΟΤΙ [type of equipment] ΣΥΜΜΟΡΦΩΝΕΤΑΙ ΠΡΟΣ ΤΙΣ ΟΥΣΙΩΔΕΙΣ ΑΠΑΙΤΗΣΕΙΣ ΚΑΙ ΤΙΣ ΛΟΙΠΕΣ ΣΧΕΤΙΚΕΣ ΔΙΑΤΑΞΕΙΣ ΤΗΣ ΟΔΗΓΙΑΣ 1999/5/ΕΚ.

Français [French]	Par la présente [nom du fabricant] déclare que l'appareil [type d'appareil] est conforme aux exigences essentielles et aux autres dispositions pertinentes de la directive 1999/5/CE.
Italiano [Italian]	Con la presente [nome del costruttore] dichiara che questo [tipo di apparecchio] è conforme ai requisiti essenziali ed alle altre disposizioni pertinenti stabilite dalla direttiva 1999/5/CE.
Latviski [Latvian]	Ar šo [name of manufacturer / izgatavotāja nosaukums] deklarē, ka [type of equipment / iekārtas tips] atbilst Direktīvas 1999/ 5/EK būtiskajām prasībām un citiem ar to saistītajiem noteikumiem.
Lietuvių [Lithuanian]	Šiuo [manufacturer name] deklaruoją, kad šis [equipment type] atitinka esminius reikalavimus ir kitas 1999/5/EB Direktyvos nuostatas.
Nederlands [Dutch]	Hierbij verklaart [naam van de fabrikant] dat het toestel [type van toestel] in overeenstemming is met de essentiële eisen en de andere relevante bepalingen van richtlijn 1999/5/EG.
Malti [Maltese]	Hawnhekk, [isem tal-manifattur], jiddikjara li dan [il-mudal tal-prodott] jikkonforma mal-ħtiġijiet essenzjali u ma provvedimenti oħrajn relevanti li hemm fid-Dirrettiva 1999/5/EC.
Magyar [Hungarian]	Alulírott, [gyártó neve] nyilatkozom, hogy a [... típus] megfelel a vonatkozó alapvető követelményeknek és az 1999/5/EC irányelv egyéb előírásainak.
Polski [Polish]	Niniejszym [nazwa producenta] oświadczam, że [nazwa wyrobu] jest zgodny z zasadniczymi wymogami oraz pozostałymi stosownymi postanowieniami Dyrektywy 1999/5/EC.
Português [Portuguese]	[Nome do fabricante] declara que este [tipo de equipamento] está conforme com os requisitos essenciais e outras disposições da Directiva 1999/5/CE.
Slovensko [Slovenian]	[Ime proizvajalca] izjavlja, da je ta [tip opreme] v skladu z bistvenimi zahtevami in ostalimi relevantnimi določili direktive 1999/5/ES.
Slovensky [Slovak]	[Meno výrobcu] týmto vyhlasuje, že [typ zariadenia] spĺňa základné požiadavky a všetky príslušné ustanovenia Smernice 1999/5/ES.
Suomi [Finnish]	[Valmistaja = manufacturer] vakuuttaa täten että [type of equipment = laitteen tyyppimerkintä] tyyppinen laite on direktiivin 1999/5/EY oleellisten vaatimusten ja sitä koskevien direktiivin muiden ehtojen mukainen.
Svenska [Swedish]	Härmed intygar [företag] att denna [utrustningstyp] står i överensstämmelse med de väsentliga egenskapskrav och övriga relevanta bestämmelser som framgår av direktiv 1999/5/EG.